

Relief, direct acting guided poppet type

Common cavity, Size 10

VSBG-10A

04.11.56 - X - 85 - Z

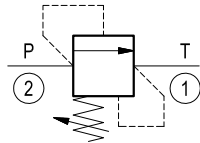
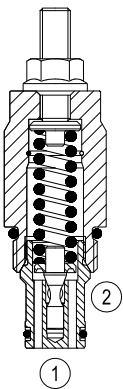

Description

Flow is blocked from 2 to 1 until pressure increases to meet the selected valve setting, lifting the poppet from its seat and allowing relief flow through port 1 to tank. Pressure at port 1 is additive to the relief setting of the valve. The unique Bosch rexroth oil control poppet design provides enhanced stability at all flows and pressures.

Performance

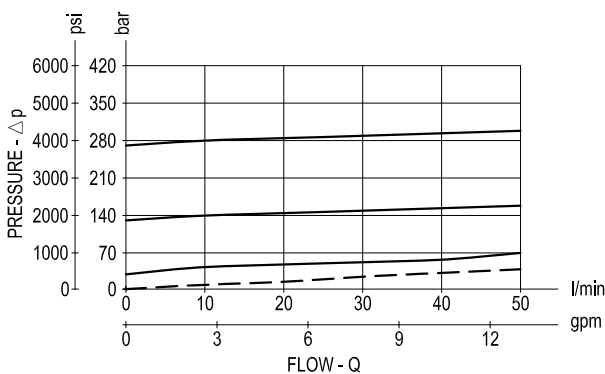

Technical data

Max. operating pressure port 1 (P)	bar (psi)	350 (5000)
Max. pressure admitted port 2 (T)	bar (psi)	350 (5000)
Flow. range	l/min. (gpm)	50 (13)
Max. internal leakage (*)	drops/min.	15
Fluid temperature range	°C (°F)	-30 to 100 (-22 to 212)
Installation torque	Nm (ft-lbs)	41-47 (30-35)
Weight	kg (lbs)	0.2 (0.44)
Cavity		CA-10A-2N see data sheet RE 18325-70
Seal kit (**)	code material no.	RG10A2010530100 R901111366
Fluids		Mineral-based or synthetics with lubricating properties at viscosities of 10 to 500 mm ² /s (cSt)
Filtration		Nominal value max. 10µm (NAS 8) ISO 4406 19/17/14
Installation		No restrictions
Other general technical data		See data sheet RE 18350-50

(*) Max. to 80% of nominal setting

(**) Only external seals for 10 valves

Dimensions

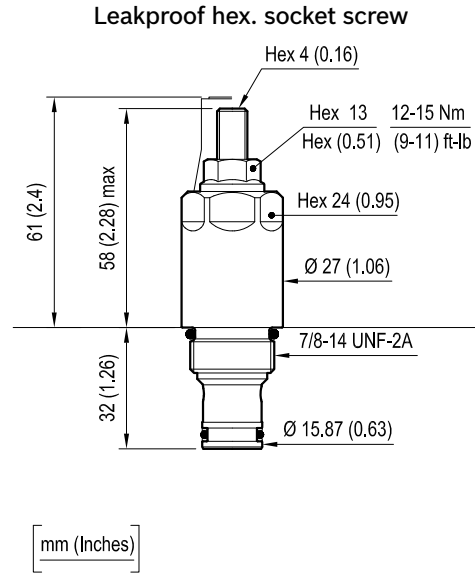

OPTION
 Tamper resistant cap
 ordering code 11.04.23.002
 Mat. no. R930000752

mm (Inches)

Ordering code

04.11.56	X	85	Z	00	*
----------	---	----	---	----	---

Relief, direct acting guided poppet type

Adjustments
 = 03 Leakproof hex. socket screw

Common cavity, Size 10

Series 0/A to L
 unchanged performances and dimensions

Version and options standard

SPRINGS			
	Adj. press. range bar (psi)	Pressure increase bar/turn (psi/turn)	Std. setting bar (psi) Q=5 l/min
= 05	5-70 (75-1000) (*)	16 (232)	50 (725)
= 10	35-140 (500-2000)	24 (348)	100 (1450)
= 20	105-210 (500-3000)	54 (783)	200 (2900)
= 35	175-350 (2500-5000)	84 (1218)	350 (5000)

Note: Special settings available. Contact factory authorized representative for ordering code
 (*) minimum pressure setting intended with Q=5 l/min (1.3 gpm)

Type	Material number
041156038505000	R901157894
041156038510000	R901113622
041156038520000	R901113624
041156038535000	R901113626

Type	Material number