

MODEL
CWIG

5:1 pilot ratio, vented counterbalance valve
CAPACITY: 480 L/min. | CAVITY: T-24A

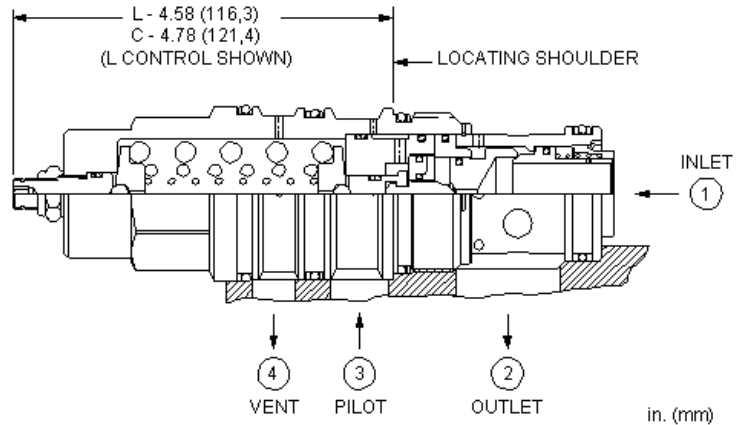
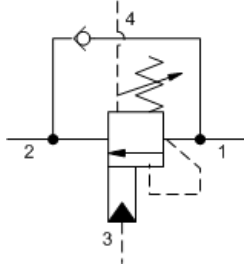

CONFIGURATION

L	Control	Standard Screw Adjustment
G	Functional Setting Range	2000 - 6000 psi (140 - 420 bar), 4000 psi (280 bar) Standard Setting
N	Seal Material	Buna-N
(none)	Material/Coating	Standard Material/Coating

Vented counterbalance valves with pilot assist are meant to control an overrunning load. The check valve allows free flow from the directional valve (port 2) to the load (port 1) while a direct-acting, pilot-assisted relief valve controls flow from port 1 to port 2. Pilot assist at port 3 lowers the effective setting of the relief valve at a rate determined by the pilot ratio. Backpressure at port 2 does not affect the valve setting because the spring chamber references the vent (port 4).

Other names for this valve include motion control valve and over center valve.

TECHNICAL DATA

Cavity	T-24A
Series	4
Capacity	480 L/min.
Pilot Ratio	5:1
Maximum Recommended Load Pressure at Maximum Setting	320 bar
Maximum Setting	420 bar
Factory Pressure Settings Established at	30 cc/min.
Maximum Valve Leakage at Reseat	0,3 cc/min.
Check Cracking Pressure	1,5 bar
Adjustment - Number of Counterclockwise Turns to Increase Setting	5
Operating Characteristic	Standard
Reseat	>85% of setting
Valve Hex Size	41,3 mm
Valve Installation Torque	475 - 508 Nm
Adjustment Screw Internal Hex Size	4 mm
Locknut Hex Size	15 mm
Locknut Torque	9 - 10 Nm
Seal kit - Cartridge	Buna: 990-024-007
Seal kit - Cartridge	Polyurethane: 990-024-002
Seal kit - Cartridge	Viton: 990-024-006
Model Weight	1.60 kg.

4-Port Vented

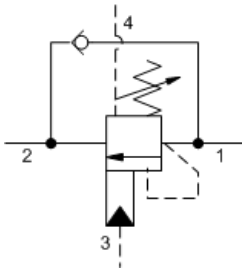

4-Port Vented, Non-adjustable

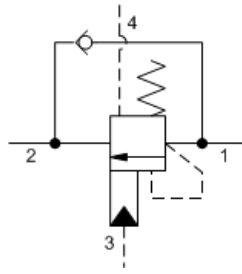

TECHNICAL FEATURES

- Counterbalance valves should be set at least 1.3 times the maximum load induced pressure.
- Turn adjustment clockwise to decrease setting and release load.
- Full clockwise setting is 200 psi (14 bar).
- All 4-port counterbalance, load control, and pilot-to-open check cartridges are physically interchangeable (i.e. same flow path, same cavity for a given frame size).
- Reseat exceeds 85% of set pressure when the valve is standard set. Settings lower than the standard set pressure may result in lower reseal percentages.
- Pressure at port 4 is added to the effective relief setting at a rate of 1 plus the pilot ratio times the pressure.
- Sun counterbalance cartridges can be installed directly into a cavity machined in an actuator housing for added protection and improved stiffness in the circuit.
- This valve has positive seals between all ports.
- With vented valves, a lower pilot ratio may be required to achieve machine stability compared to non-vented valves.
- Incorporates the Sun floating style construction to minimize the possibility of internal parts binding due to excessive installation torque and/or cavity/cartridge machining variations.

PERFORMANCE CURVES

Free Flow and Piloted Open Pressure Drop

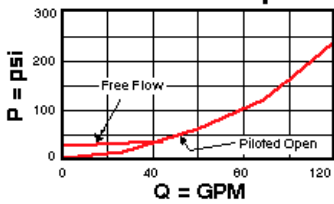

Free Flow and Piloted Open Pressure Drop

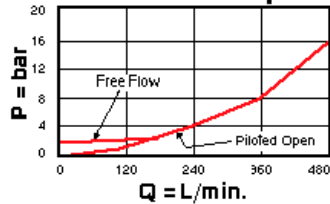

Typical Relief Characteristics

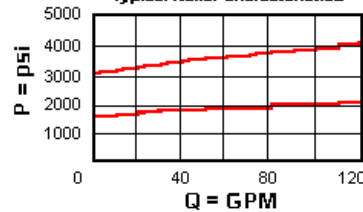

Typical Relief Characteristics

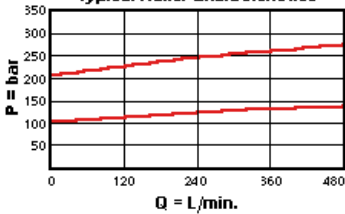

CONFIGURATION OPTIONS

CONTROL

Preferred Options	L	Standard Screw Adjustment
Standard Options	C	Tamper Resistant - Factory Set

FUNCTIONAL SETTING RANGE

Preferred Options	G	2000 - 6000 psi (140 - 420 bar), 4000 psi (280 bar) Standard Setting
Standard Options	F	1000 - 2500 psi (70 - 175 bar), 2000 psi (140 bar) Standard Setting

SEAL MATERIAL

Preferred Options	N	Buna-N
Standard Options	V	Viton

MATERIAL/COATING

Standard Options		Standard Material/Coating
	/AP	Stainless Steel, Passivated
	/LH	Mild Steel, Zinc-Nickel

Copyright © 2002-2014 Sun Hydraulics Corporation. All rights reserved.