



Codice ordinazione / Ordering code: **PM50**

01	Pompa a mano doppio pompaggio per cilindro a semplice effetto (Double pumping for single acting cylinder)	PM50
	Con soffietto (With rubber protection)	P
	Senza rubinetto di scarico con valvola di massima (Without unloading valve With relief valves)	WRV
02	Optional	W
	Senza rubinetto di scarico (Without unloading valve)	W
	Con joystick (With joystick)	J
	Con leva di scarico Ø 27 mm (With unloading lever Ø 1.06 inch)	L
	Con rubinetto di scarico e valvola di massima (With unloading and relief valves)	RRV

La pompa viene fornita con leva di azionamento L=600 mm
The pump is supplied with acting lever 23.6 inch long

Schema idraulico - Hydraulic circuit

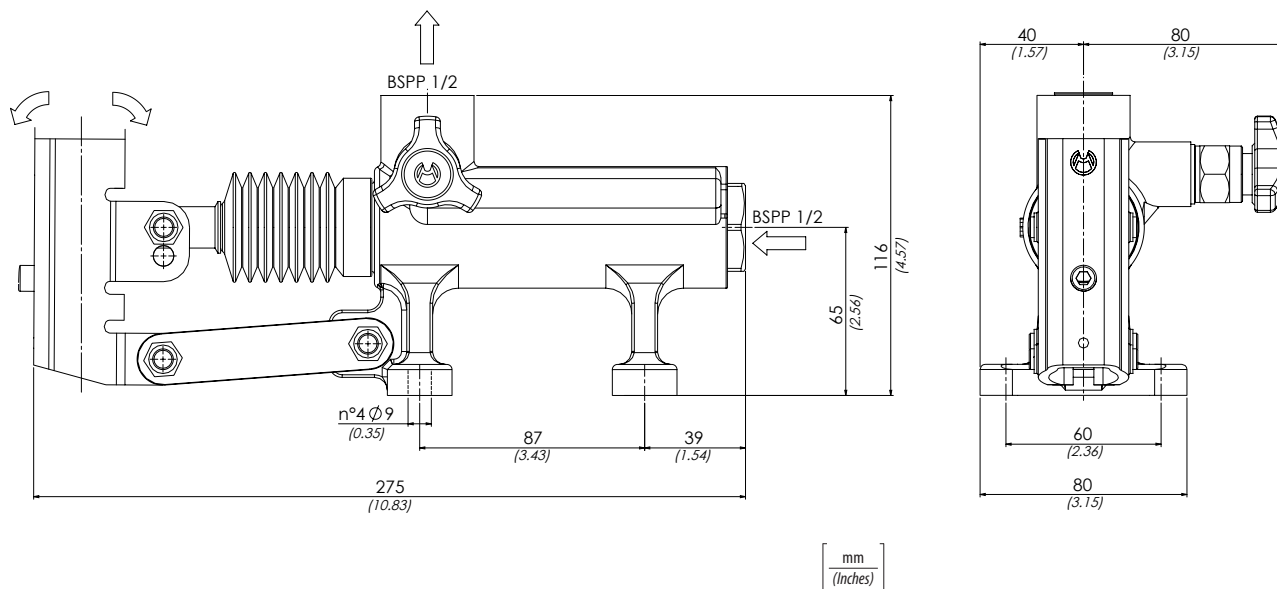
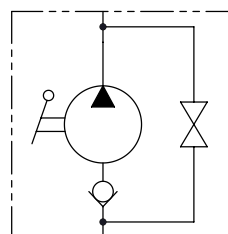

Dati tecnici - Technical data

Olio idraulico/Mineral oil	ISO 6743/4 (DIN 51524)	
Viscosità olio/Oil viscosity	15-250 mm ² /s (15 to 250 cSt)	
Classe di contaminazione max con filtro Max contamination index with filter	ISO 4406:1999 Classe 19/17/14	
Temperatura dell'olio/Oil temperature	-20°C +80°C	-4°F + 176°F
Temperatura ambiente/Ambient temperature	-20°C +50°C	-4°F + 122°F
È indispensabile l'utilizzo di un filtro per proteggere la valvola (filtrazione consigliata 15 µm) It is necessary a filter use to protect the valve (advised filtration 15 µm)		

Caratteristiche tecniche - Technical characteristics

Tipo Type	Cilindrata (cm ³) Displacement (in ³)	Pressione ottimale (bar) Optimal pressure (PSI)	Pressione max (bar) Max pressure (PSI)	Peso approssimativo (kg) Approx weight (lb)
PM50	50 (3.05)	80 (1160)	280 (4060)	4,2 (9.25)

WRV

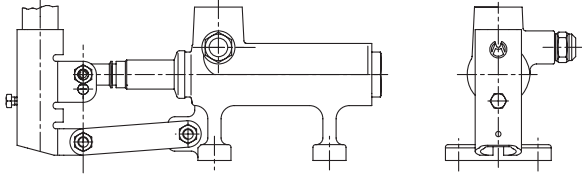

Valvola di massima
(Relief valve)

Molla 40/350 bar
Spring 580/5075 PSI

Taratura Standard 100 bar
(Standard Setting) 1450 PSI

L

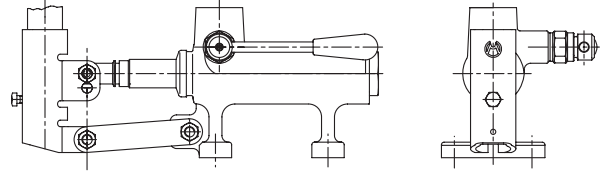

W

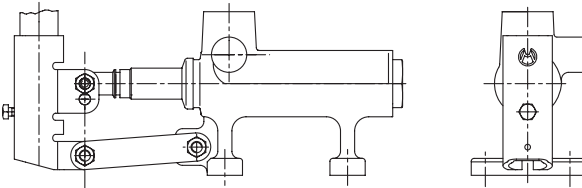

J

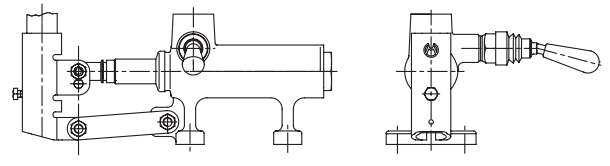

RRV

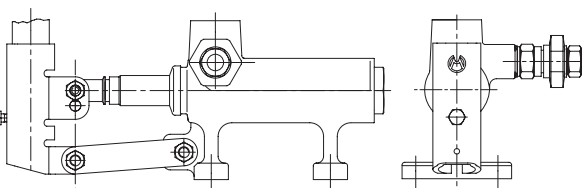

Sforzo esercitato all'estremità della leva - Effort operating at the end of the lever

